

## IP Speaker Spacing & Coverage Guideline



**8189 Surface Mount Speaker**



**8188 Drop Ceiling Mount Speaker**



**8180 Wall Mount Speaker**



**8186 Horn Speaker (weatherproof)**

**Disclaimer:** The information contained is intended to be a **guideline**. Actual coverage may vary depending on the acoustic characteristics of the physical environment. For more accurate coverage and placement of speakers, please consult a professional acoustician or contact Algo.



# Ceiling Speaker Spacing Guideline For Hallway, Common & Office Areas (8188 & 8189 Speakers)

8188/8189		Carpet or High Occupancy (feet)			Hard Floor Low Occupancy (feet)		
		Attenuation			Attenuation		
Ceiling	Distance	9dB	6dB	3dB	9dB	6dB	3dB
Height (feet)	To Listening Plane (feet)	GOOD	BETTER	BEST	GOOD	BETTER	BEST
7	2	8	8	4	12	8	8
8	3	12	8	8	16	12	8
9	4	16	12	8	20	16	12
10	5	20	16	12	24	20	12
12	7	28	20	16	32	24	16
14	9	36	24	20	40	32	20
16	11	44	28	24	48	40	24
20	15	56	40	32	68	52	36
24	19	72	48	36	84	64	44
28	23	88	60	44	100	80	52

If not highly reverberant spaces, hard floors can help reflect sound back to the listener.

Strategically place speakers only where needed.

## Maximum Distance Guideline vs Ambient Noise Level (8186 Horn & 8180 Wall Mount Speakers)

Note: Wind & Air Absorption is Ignored

Maximum Speaker to Listener Distance (feet)

Ambient Level* (dBA)	8180 Signalling		8180 Paging		8186 Signalling		8186 Paging	
	Marginal	Good	Marginal	Good	Marginal	Good	Marginal	Good
50	3680	1844	463	292	13058	6544	1644	1037
55	2070	1037	261	164	7343	3680	924	583
60	1164	583	147	92	4129	2070	520	328
65	654	328	82	52	2322	1164	292	184
70	368	184	46	29	1306	654	164	104
75	207	104	26	16	734	368	92	58
80	116	58	15	9	413	207	52	33
85	65	33	8	5	232	116	29	18
90	37	18	5	3	131	65	16	10
95	21	10	3	2	73	37	9	6
100	12	6	1	1	41	21	5	3
105	7	3	1	1	23	12	3	2
110	4	2			13	7	2	1

\*Note: Not NC Curves

Mount 8186 Back-to-Back or Clover Leaf Placement for Larger Areas. Angle to Listening Plane at ~5 feet & Adjust as Required.

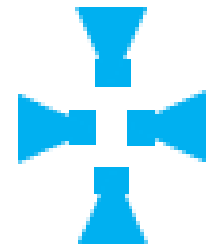

Scenario: Audio requirements: voice paging, emergency alerting & bell tones.

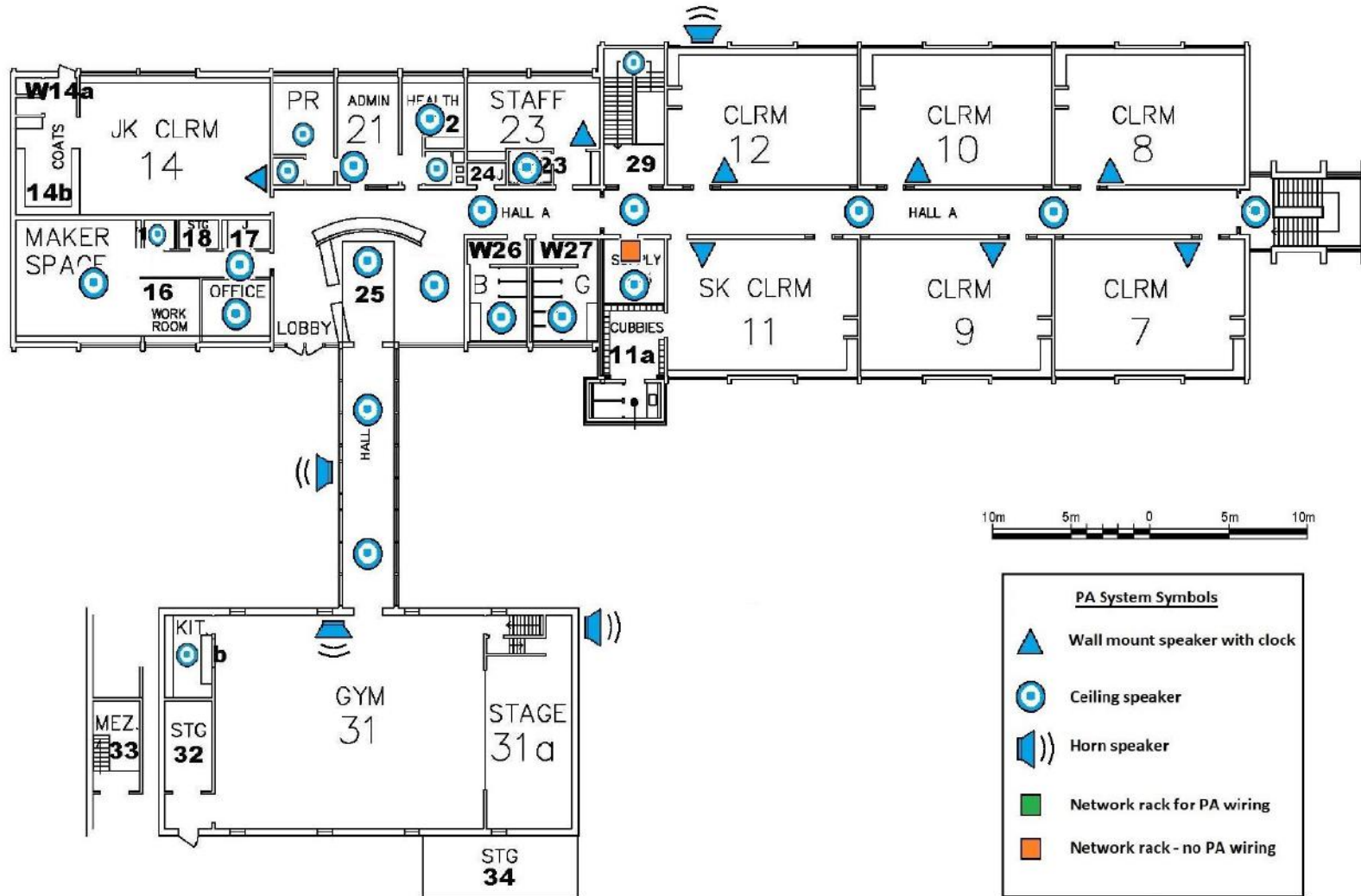

**Scenario:** ~25,000 sq. ft. cafeteria, 9 & 10 ft. ceiling heights, audio requirements: voice paging & emergency alerting

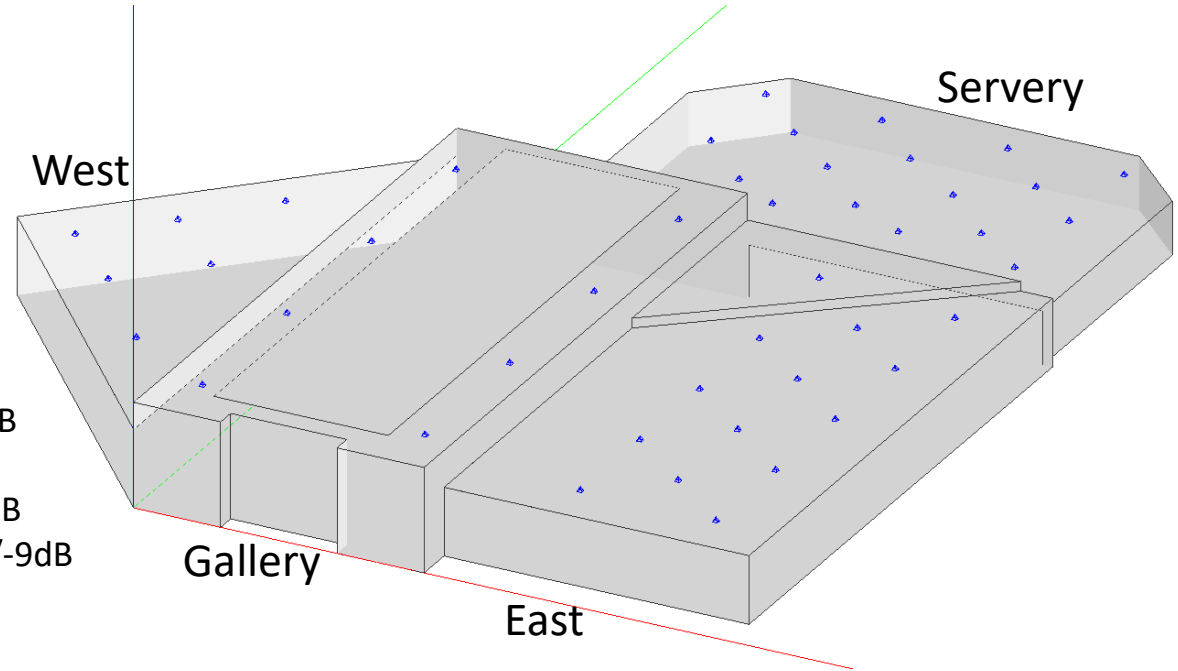
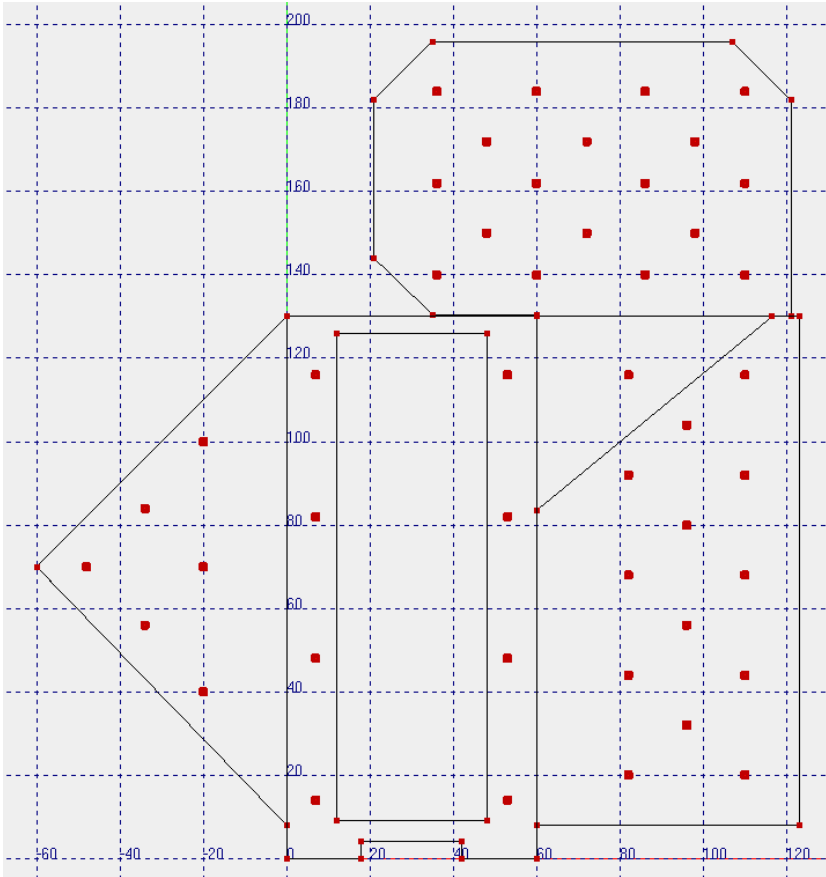

6 x 8188 in West -3/-6dB  
8 x 8188 in Gallery  
14 x 8188 in East -3/-6dB  
18 x 8188 in Servery -6/-9dB

Note:

Speaker locations were determined by uniformity of direct SPL at 2 kHz. Count reduction possible if additional variance acceptable

**Scenario:** 160,000 sq. ft. warehouse, 32 ft. ceiling height, forklift ambient noise level ~70-75 dBA, shelving to ~ 24 ft., audio requirements: voice paging

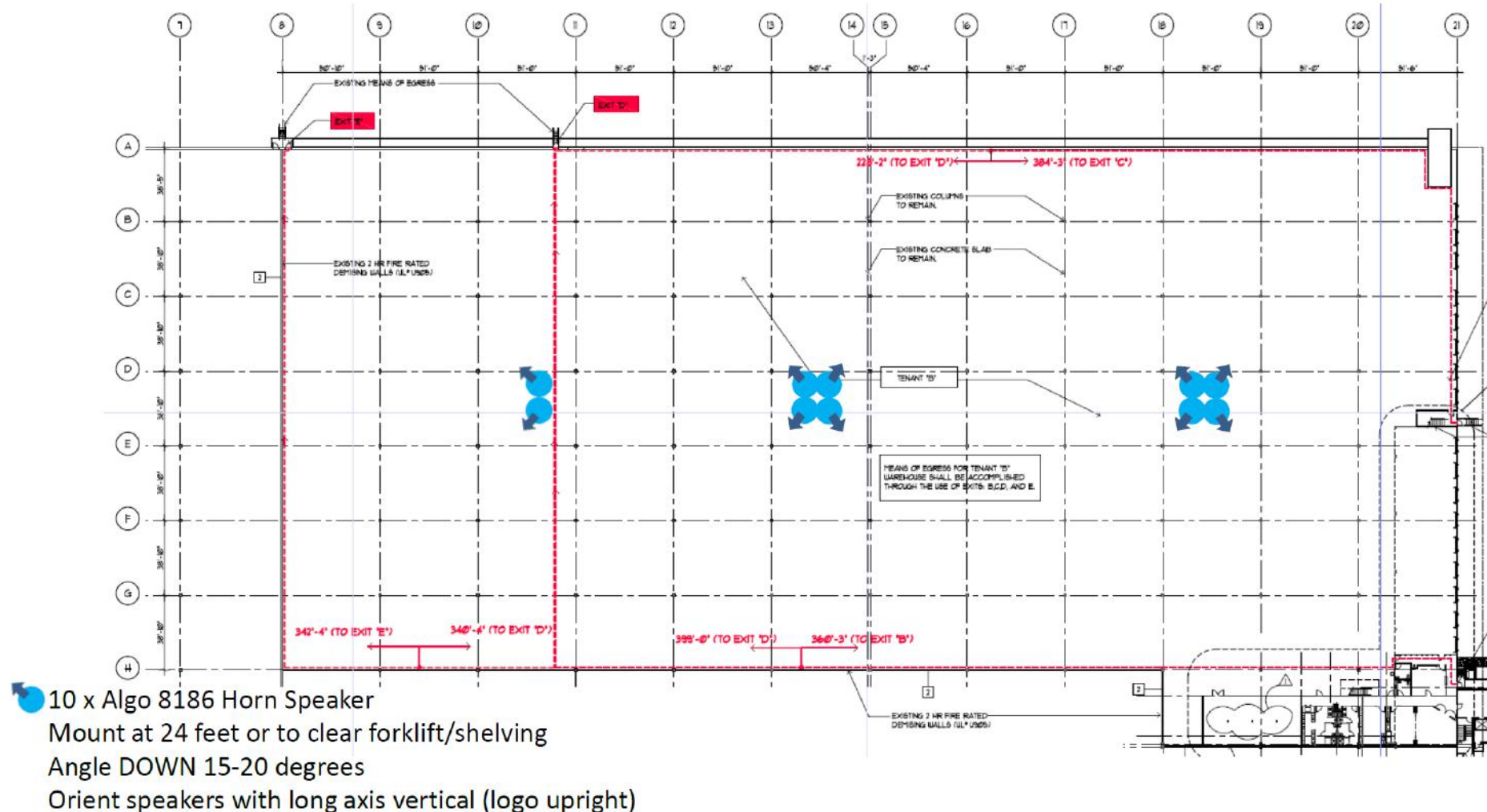

## Warehouse Alerting Example - 8186 Horn Speaker + 8301 Scheduler



**Scenario:** 1.2 million sq. ft. warehouse, 36 ft. ceiling height, no shelving, up to 65 dBA ambient noise level, audio requirements: shift change & emergency alert tones – no voice paging

Layout designed for alerting/signalling only. Results for voice paging will depend on ambient noise and reverberation.

Acoustic density of shelves at columns 22-23 and 32-33 unknown.

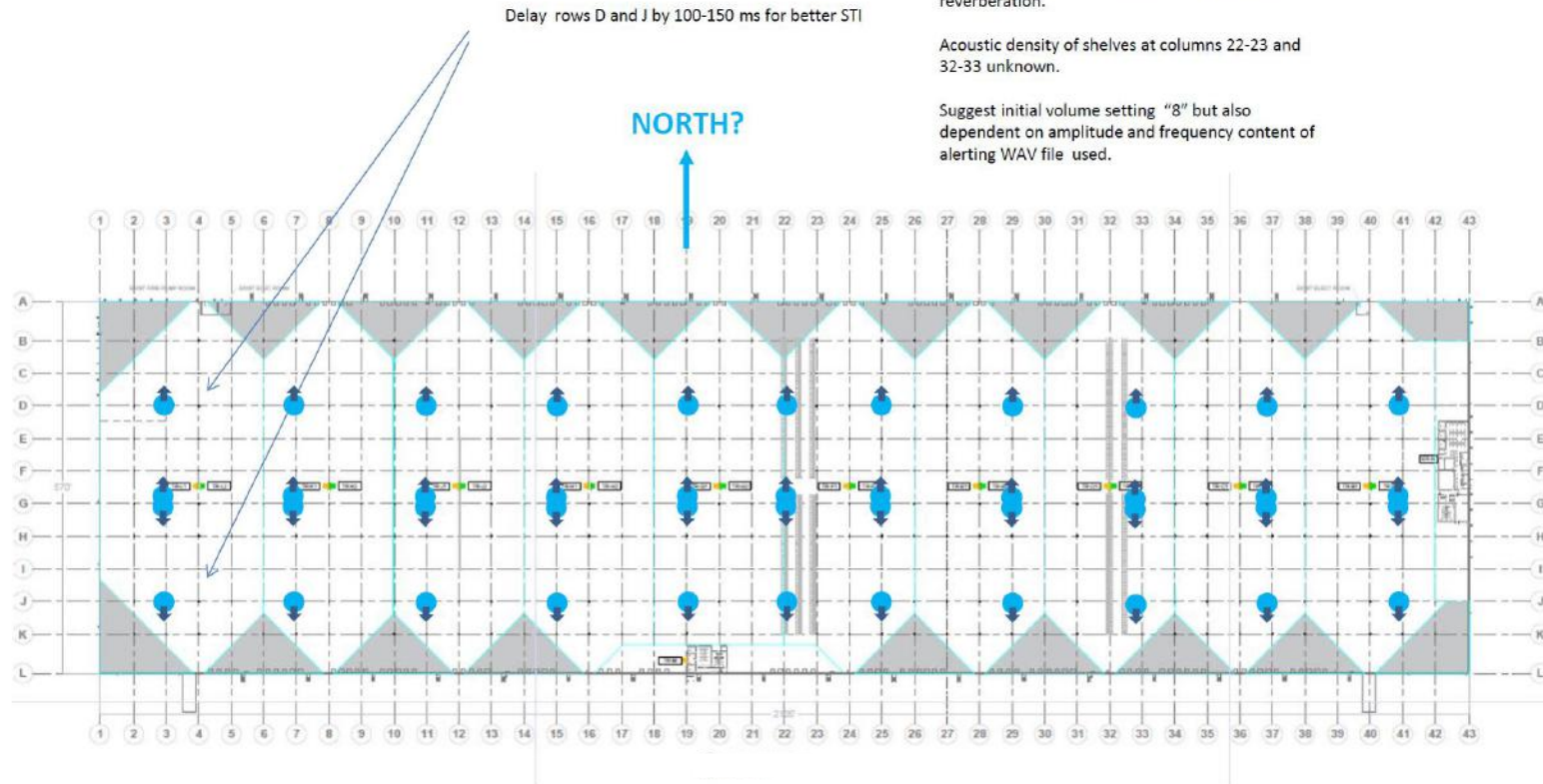
Suggest initial volume setting "8" but also dependent on amplitude and frequency content of alerting WAV file used.



-  1 x 8186, aiming north, 15-20 degrees down, 24 feet, long axis vertical
-  2 x 8186, one aiming south and one aiming north, 15-20 degrees down, 24 feet, long axis vertical
-  1 x 8186, aiming south, 15-20 degrees down, 24 feet, long axis vertical

**Scenario:** Tall shelving in a warehouse with aisles 10 (w) x 350 (l) ft., ceiling height 34 ft., audio requirements: voice paging & emergency alerting

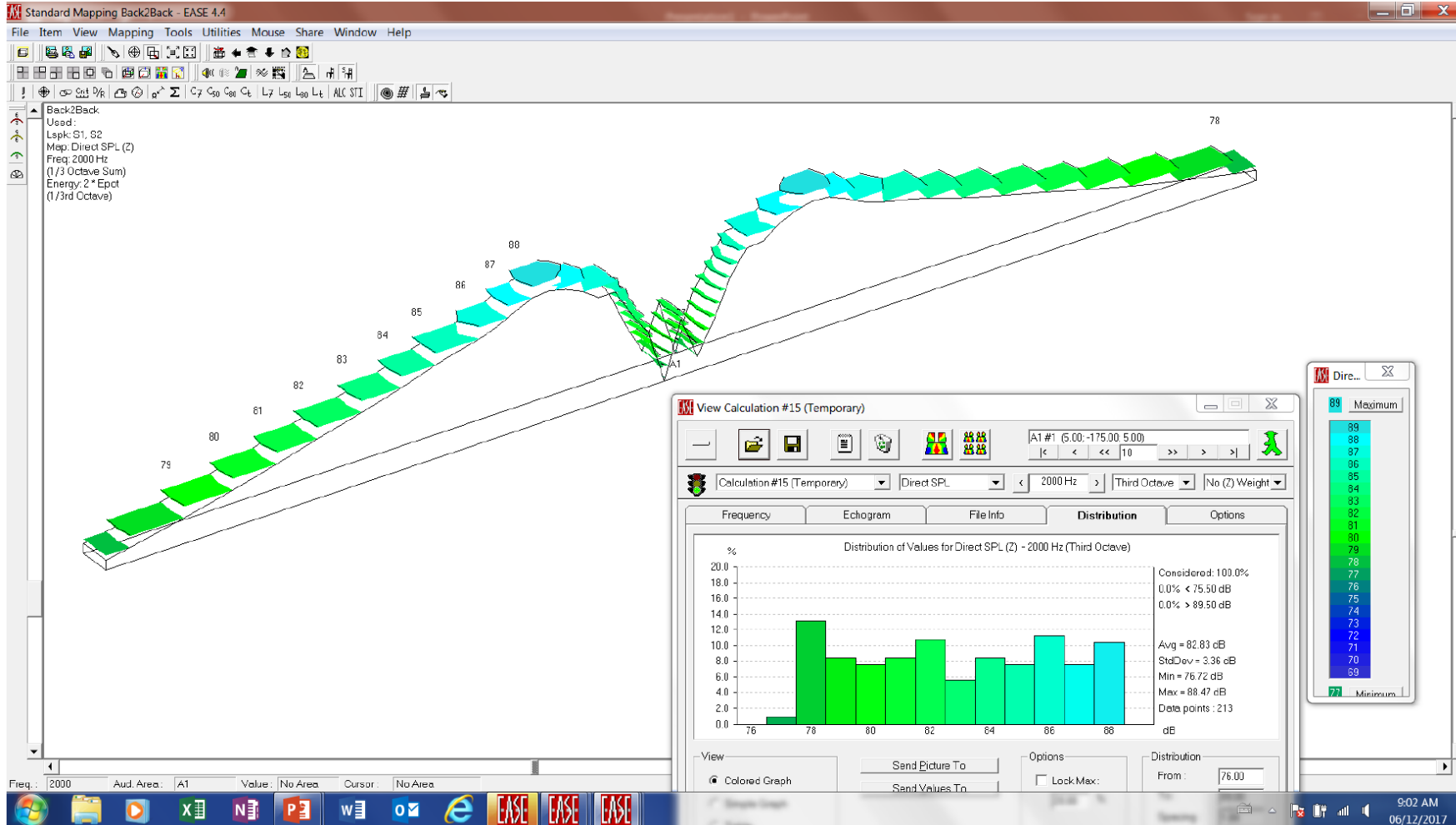

2 x 8186 horns positioned back-to-back in each aisle mounted at 30-34 ft. height to clear shelving, angled at 20 degrees down.

**Note:** A densely packed shelf will likely require speakers in every aisle due to the shadowing effect of audio blocked by opaque barriers. See illustration on next page.



**Scenario:** Tall shelving densely packed in a warehouse. Unless horns are placed in each aisle, users in an adjoining aisle will not properly hear a voice announcement due to a shadowing effect of audio caused by the opaque materials stored on tall shelving. Intelligibility will be impacted in such a scenario without additional speakers.

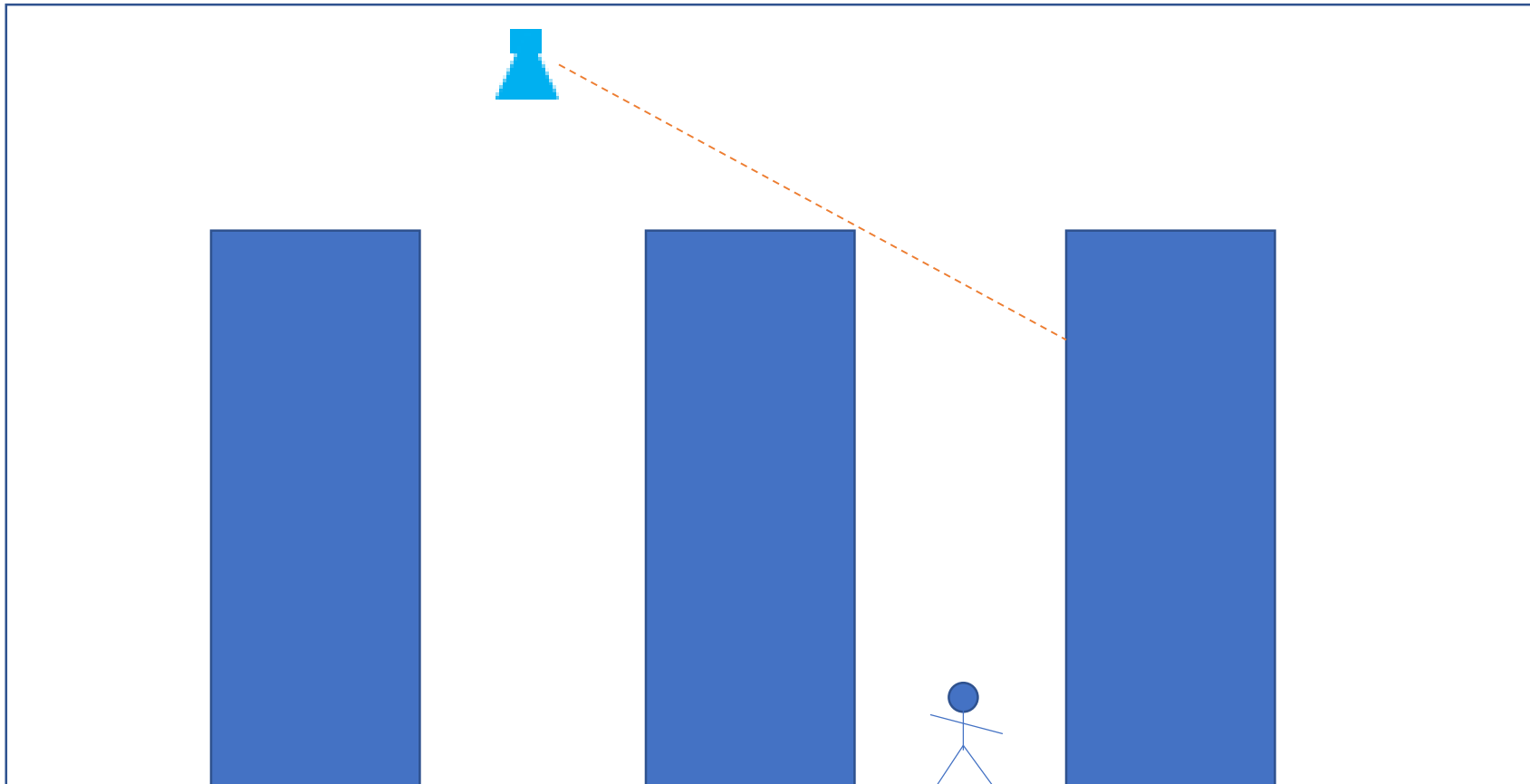

**Scenario:** Outdoor voice paging in an open field

8186 Open Field 20 Foot Height  
2kHz Direct SPL 1/3 Octave  
Vertical Orientation  
Aimed -5 Degrees From Horizontal

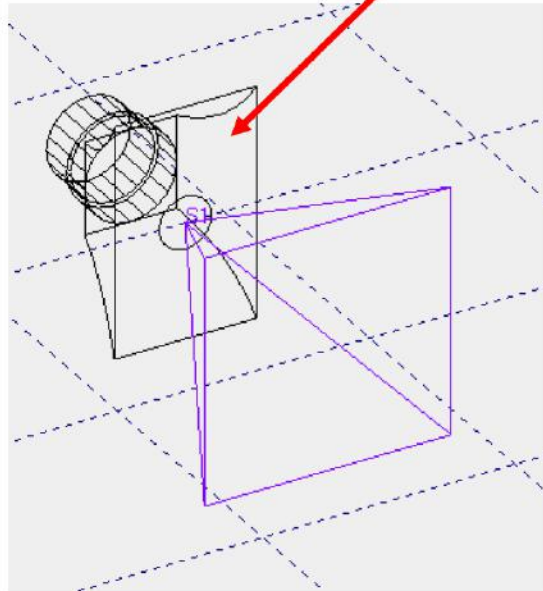

"0 degrees rotation"

500' x 500'

